

# POOL / SPA PROFILE GUIDE

Use this guide to aid you in taking site measurements. Accurate site measurements are required in order to verify that the lift you want is going to work for your application. Please be as accurate and thorough as possible. If you do not see a profile that closely matches your pool profile, please draw your own profile and complete the appropriate measurements. Fax or email completed Profile Guides back to Aqua Creek Products.

FAX: (406) 549-2602

EMAIL: Your sales rep (Subject: Pool Spa Profile Guide)

## ① Roll Out Profile

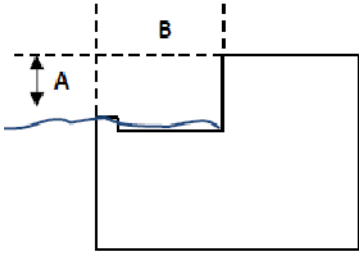

## ② Partially Recessed Profile

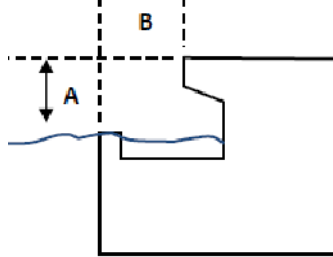

## ③ Fully Recessed Profile

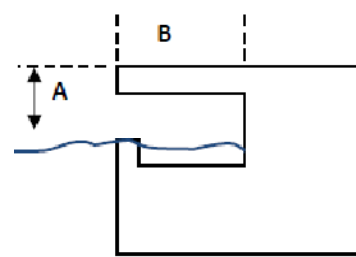

## ④ Fully Recessed w/Parapet

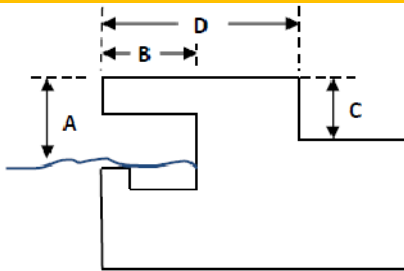

## ⑤ Flush with Deck Profile

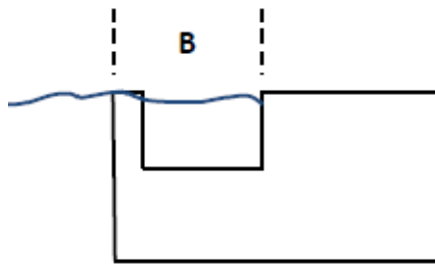

## ⑥ Squared Edge Profile

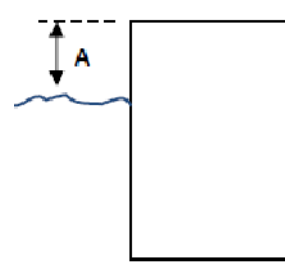

## ⑦ Raised Pool/Spa Profile

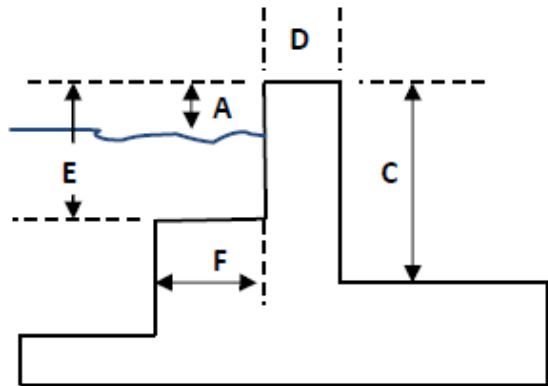

PROFILE # \_\_\_\_\_

POOL TYPE:

Commercial  Residential

DECK MATERIAL:

Concrete  Wood  Other

**MEASUREMENTS:** \_\_\_\_\_

A = Deck to Water \_\_\_\_\_ Inches

B = Gutter width \_\_\_\_\_ Inches

**If Applicable:**

C = Height of Parapet (Curb/Wall) \_\_\_\_\_ Inches

D = Width of Parapet (Curb/Wall) \_\_\_\_\_ Inches

E = Spa Seat Depth (Top of wall to seat) \_\_\_\_\_ Inches

F = Spa Seat Width \_\_\_\_\_ Inches



QUESTIONS? Call Aqua Creek @ (888) 687-3552 or (406) 549-0769